

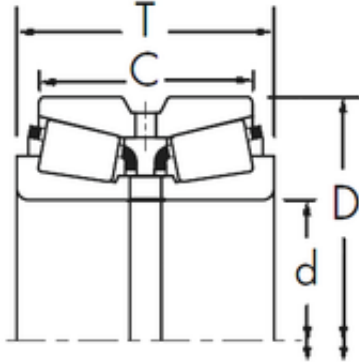

BEARING DRIVESHAFT, INC.

Timken 461/452D tapered roller bearings



Bearing No. 461/452D

Size	42.85x107.95x65.09 mm
Bore Diameter	42,85 mm
Outer Diameter	107,95 mm
Width	65,09 mm
d	42,85 mm
D	107,95 mm
T	65,09 mm
C	53,975 mm
R	0,8 mm
r	0,8 mm

461/452D Bearing 2D drawings and 3D CAD models